

Technical Manual



TABLE OF CONTENTS

1.	Introduction	1
1.1	Revision History	1
2.	Warnings, Cautions, Contraindications	2
2.1	Contraindications	2
2.2	Warnings	2
2.3	Cautions	3
3.	Specifications	4
3.1	Description of the Device	4
3.2	Electrical Specifications	5
3.3	Mechanical Specifications	5
3.4	Performance Specifications	5
3.5	Accuracy of Controls and Indications	6
3.6	Operation, Storage and Transport Conditions	6
3.7	Standards and Approvals	7
3.8	Symbol Definitions	7
4.	General Information of the Device	8
4.1	Information on all the Measuring Sensors and Display Unit	8
4.2	The Pneumatic Flow Path	9
4.3	Operator-detachable Breathing Gas Pathway Components	10
5.	Operation	11
5.1	Important Information	11
6.	Support Information	12
6.1	Note	12
6.2	Upgrade of Software	12
6.3	Electrical Safety Test	12
6.4	Replacement Parts	13
6.5	Error Codes	13
7.	Performance Checks	14
7.1	Note	14
7.2	Pressure Sensor Test	14
7.3	Heater Plate Test	15
7.4	ThermoSmart™ Breathing Tube Disconnection Indicator	15
8.	Device Disposal Instructions	15
	APPENDIX A: IEC60601-1-2 EMC TABLES	16

1. Introduction

Refer to Use and Care Manual for detailed instruction and application of the devices.

This technical manual refers to the F&P ICON Series as “the device”.

1.1 Revision History

REVISION	DATE	COMMENTS
A	August 2009	First Release
B	June 2010	The Specifications section updated. The Operation section updated. The Servicing Information section updated. An Upgrade of Software and an Electrical Safety Test section added under the Servicing Information section. A Performance Check section added. The address of Fisher & Paykel Healthcare representatives updated.
C	January 2011	Warnings, Cautions, Contraindications section updated. General section updated with new Plug Lead spare parts and a new Filter part number from 900ICON212 to 900ICON503. Service Information section updated with new replacement parts and error codes.
D	June 2011	SmartStick™ name change to InfoUSB™. Updated Models and Features Matrix. Amended power supply voltage from 110 -115 V to 100-115 V. Amended Humidity RH levels from 5 - 95% to 15 to 95%. Part number change from SmartStick Studio CD 900ICON108 to F&P Studio CD 900ICON112. Part number change from InfoSmart CD 900ICON100 to F&P InfoSmart CD 900SW100. ThermoSmart Breathing tube disconnection indicator updated as the logo no longer flashes. Warnings section updated (order and placement only).
E	September 2011	Warnings Section updated. Updated Models and Features Matrix Intended Use section now states that the device is suitable for continuous operation. The Symbol Definitions section has been updated to change the book symbol to the triangle symbol.
F	May 2012	Section 6 renamed in Table of Contents. Models and Features Matrix updated. 'Prescription only' symbol updated in Symbol Definitions section. Servicing Information section renamed to Support Information. Replacement Part section updated. InfoUSB changed to InfoUSB 2. Plug leads, protective carry case, and carry case straps removed. Japanese address and contact information removed from back page.
G	February 2013	Models and Features Matrix updated Included new Brazil INMETRO symbol Changed wording for section 5.1.4 to refer to section 6.5 error codes Added 900ICON205 and 900ICON217

2. Warnings, Cautions, Contraindications

The device treats Obstructive Sleep Apnea (OSA) by delivering a flow of continuous positive airway pressure (CPAP) at a level prescribed by the physician, to splint open the airway and prevent airway collapse.

- Do not modify this equipment without authorization of the manufacturer. The only modification allowed to be performed is the upgrade of the software. Refer to section 6 for further details.

2.1 Contraindications

- Research indicates that the following pre-existing conditions may contraindicate the use of positive pressure for some patients: pneumothorax, bullous lung disease, pneumocephalus, cerebrospinal fluid leak, recent cranial surgery or trauma, abnormalities of the cribriform plate, pathologically low blood pressure or in patients whose upper airways are bypassed.

2.1.1 Precautions:

- The safety and effectiveness of positive pressure has not been established in patients with respiratory failure or chronic obstructive pulmonary disease.
- The safety and effectiveness of the auto-adjusting device has not been established in patients with congestive heart failure, obesity hypoventilation syndrome or central sleep apnea.

2.1.2 Adverse effects:

- Nosebleeds, ear and sinus discomfort may occur from the use of positive pressure therapy.

2.2 Warnings

2.2.1 To avoid electric shock from the device:

- Only operate if the device, power cord and plug are dry and in good working order.
- Disconnect the power cord, discontinue use immediately and seek advice from your healthcare provider if water damage occurs to your device.
- Do not store or use the device where it can be pulled into water.

2.2.2 To avoid choking, or inhalation of a foreign object:

- Never place any non-approved objects into any opening of the device, ThermoSmart Breathing Tube, Breathing Tube or mask.
- Ensure the recommended filter is fitted to the device before use.
- Ensure the ThermoSmart Breathing Tube or Breathing Tube is positioned so it can not become entangled with the body or furniture during sleep.

2.2.3 To avoid burns:

- Do not fill the chamber with hot water.
- After use, wait for the water to cool before touching, carrying or emptying the Water Chamber.
- Do not touch the water in the chamber while the device is operating.
- Position the ThermoSmart Breathing Tube so it is uncovered and free from bedding or other materials. Do not lie on it and avoid prolonged skin contact.

2.2.4 Other:

- Ensure the device is stored on a level surface, level or below head height, to prevent water entering the tubing and the device enclosure.
- The device is not intended to be used as a life-supporting device.
- The device complies with the electromagnetic compatibility requirements of IEC60601-1-2. In certain circumstances the device may affect or be affected by nearby portable mobile radio frequency communication equipment, due to the effects of electromagnetic interference. If this should happen, try moving your device or the location of the equipment causing interference, or alternatively consult your healthcare provider.
- Do not block the exhaust flow holes of the mask as they are designed to allow a continuous flow of air out of the mask and CO₂ re-breathing may occur which can be hazardous.
- In the event of power failure, machine malfunction or if the device is turned off, remove the mask immediately as the flow through the mask may be insufficient to clear all exhaled gas and accordingly CO₂ re-breathing may occur which can be hazardous.
- The device is not suitable for use in environments with flammable anaesthetic mixtures with air, oxygen or nitrous oxide.

2.2.5 To ensure optimal therapy:

- Do not operate the device, chamber, ThermoSmart Breathing Tube or Breathing Tube if it is dropped, damaged or not working as intended.
- Pressure adjustments should only be made by a qualified healthcare provider.
- Only use masks, ThermoSmart Breathing Tubes, Breathing Tubes and accessories compliant with ISO 17510-2, distributed for use with this device, and recommended by Fisher & Paykel Healthcare or your healthcare provider.
- On models without automatic altitude adjustment, ensure the altitude level is manually adjusted to ensure optimal pressure delivery.
- Do not use the device without a water chamber in place.
- If using the device without water in the Water Chamber it is recommended to set the humidity level to zero.

2.2.6 Using supplemental oxygen with your device:

- Supplemental oxygen can be administered at the mask end of the ThermoSmart Breathing Tube or Breathing Tube or with an Oxygen Elbow.
Note: At a fixed flow rate of supplemental oxygen the inhaled oxygen concentration will vary, depending on the pressure settings, the patient's breathing pattern, mask selection and leak rate.
- Ensure there is no obstruction downstream of the Oxygen Port as this can affect the delivered oxygen concentration.
- Oxygen concentration should be measured at the point of delivery to the patient.
- Avoid the risk of fire:
 - Only use oxygen when the device is operating. If the device is turned off it can lead to accumulation of oxygen within the device.
 - Ensure adequate ventilation is provided around the device.
 - Remove any source of ignition: such as cigarettes, an open flame, or materials which burn or ignite easily at high oxygen concentration.
 - Keep oxygen regulators, cylinder valves, tubing, connections and all other oxygen equipment away from oil, grease or greasy substances. Spontaneous and violent ignition may occur if these substances come into contact with oxygen under pressure.

2.3 Cautions

2.3.1 To prevent water damage to the device:

- Remove the water chamber from the device before filling.
- Do not fill the water chamber above the maximum level.
- Do not move, carry, transport or store the device with water in the chamber.

2.3.2 General:

- Only use the device within the Operating Conditions specified in Section 3.
- Position the device so the power cord connection to the power supply is easily accessible.
- Only clean the device in accordance with the cleaning instructions set out in the CLEANING AND MAINTENANCE Section of the Use and Care Manual and only when it is disconnected from the power supply.
- Only use the F&P ICON InfoUSB™ with the device. Use of any other USB drives may cause data corruption. Do not attempt to change the directories or view the data without software distributed or designed for use with the F&P ICON.

3. Specifications

3.1 Description of the Device

3.1.1 Intended use statement:

The F&P ICON CPAP Series is for use on adult patients for the treatment of Obstructive Sleep Apnea.

The device is for use in the home or sleep laboratory.

The device is suitable for continuous operation.

The device is not intended to be used as a life supporting device.

3.1.2 Models and features:

F&P ICON Models and Features Matrix			
PERFORMANCE FEATURES	AUTO	PREMO	NOVO
Fully Integrated CPAP with Humidifications	•	•	•
ThermoSmart Technology*	•	•	•
Auto-Adjusting Pressure	•		
Efficacy Reporting (Includes AHI and Leak)	•	•	
Compliance Reporting	•	•	•
InfoUSB Removable Media	•	•	•
SensAwake™ Pressure Relief Technology	•	•	
Proportional Ramp	•	•	•
Auto-altitude Adjusting	•	•	
Leak Compensation	•	•	
Clock and AlarmTunes™ Function	•	•	•
InfoSmart™ Technologies	•	•	•
PLUG TYPE	AUTO	PREMO	NOVO
Australasia/China	ICONAAA	ICONPBA	ICONNAA
Europe	ICONAAE/ ICONAHE**	ICONPAE**/ICONPBE/ ICONPHE**	ICONNAE
United Kingdom/Hong Kong	ICONAAK	ICONPBK	ICONNAK
North America (Models numbers with HT include heated breathing tube)	ICONAAN/ICONAAN-HT	ICONPBN/ICONPBN-HT	ICONNAN/ICONNAN-HT
Brazil	ICONAAB+	ICONPBB+	ICONNAB+
Japan/Taiwan	ICONAAJ	ICONPBJ	ICONNAJ

* In some countries the ThermoSmart Breathing Tube needs to be purchased as an accessory to activate ThermoSmart Technology

** Part may vary depending on country

3.2 Electrical Specifications

3.2.1 Mains Supply:

Rated supply voltage	Rated current input	Rated supply frequency
100-115 V	1.27 A (1.43 A Max)	50-60/400 Hz
220-240 V	1.07 A (1.21 A Max)	50-60/400 Hz

3.2.2 Means of isolating the device from the supply mains:

Mains plug of the non-detachable power supply cord.

3.2.3 Fuse rating:

F1, F2 are 3.15 A, fast acting.

Note: Fuses are not replaceable.

3.2.4 Battery life:

The non-replaceable battery on the control PCB is used for the real time clock circuit and has a life of 10 years.

3.3 Mechanical Specifications

3.3.1 Dimensions:

6.3 x 6.7 x 8.7 in (160 x 170 x 220 mm)

3.3.2 Weight:

Device: 4.8 lbs (2.2 kg)

Packed: 8.7 lbs (4.0 kg)

3.4 Performance Specifications

3.4.1 Pressure range:

4 to 20 cmH₂O (in the unlikely event of fault conditions, pressure may reach up to 29 cmH₂O)

3.4.2 Maximum flow rates at different set pressures:

Premo, Auto Models					
CPAP pressure setting (cmH ₂ O)	4	8	12	16	20
Measured pressure at patient connection port (cmH ₂ O)	3	7	11	15	19
Maximum flow rate (L/min) at patient connection port*	62	102	129	149	143

Novo Model					
CPAP pressure setting (cmH ₂ O)	4	8	12	16	20
Measured pressure at patient connection port (cmH ₂ O)	3	7	11	15	19
Maximum flow rate (L/min) at patient connection port*	47	52	57	61	65

*Maximum flow rate at the patient connection port is the maximum flow rate the device can achieve when the measured pressure at the patient connection port is 1 cmH₂O lower than the set pressure.

3.4.3 Static pressure stability:

	AUTO/PREMO	NOVO
Change at patient connection port (cmH ₂ O) at a pressure setting of 10 cmH ₂ O	0.2	0.4

3.4.4 Dynamic pressure stability:

CPAP Pressure Setting (cmH ₂ O)	4	8	12	16	20
Pressure variation (cmH ₂ O) at mask connection port – AUTO/PREMO	0.6	0.6	0.6	0.7	0.8
Pressure variation (cmH ₂ O) at mask connection port – NOVO	1.2	1.2	1.3	1.5	1.5

3.4.5 Altitude:

0 to 9,000 ft (0 to 3,000 m)

Note: Above 4,500 ft (1,500 m) the maximum operating pressure will be reduced.

3.4.6 With ThermoSmart Breathing Tube:

Maximum humidity = 36 mg/L (BTPS), 82% RH at 10 cmH₂O, with Humidity level 7 and Boost level high

Typical humidity = 24 mg/L (BTPS), 90% RH at 10 cmH₂O, with Humidity level 4 and Boost level medium

With Standard Breathing Tube:

Maximum humidity = 32.24 mg/L, 73.21% RH at 10 cmH₂O with Humidity level 7 and Boost level high

Typical humidity = 17.97 mg/L, 85.88% RH at 10 cmH₂O with Humidity level 4 and Boost level medium

3.4.7 Gas Temperatures:

MAX = 100 °F (38 °C)

3.4.8 Noise Level:

Sound Pressure Level = 29.7 dBA

Average Sound Power Level = 37.7 dBA

3.5 Accuracy of Controls and Indications

3.5.1 Pressure:

The maximum error for displayed and delivered pressures at altitudes up to 9,000 ft (3,000 m): ± 1 cmH₂O

Standard lab conditions: 73 ± 4 °F (23 ± 2 °C), 50 ± 5 % RH, 860 hPa to 1,060 hPa.

3.5.2 Flow:

Maximum measurement error over full flow range: ± 15 LPM

3.6 Operation, Storage and Transport Conditions

	Operation	Transport	Storage
Ambient temperature	5 °C to 35 °C 41 °F to 95 °F	-10 °C to 60 °C 14 °F to 140 °F	-10°C to 60°C 14 °F to 140°F
Humidity	15 to 95 % RH		

3.7 Standards and Approvals

3.7.1 Standards under which this device is designed to perform:

- IEC60601-1: 1988 + A1 & A2
- AS3200.1.0: 1998
- EN60601-1: 1990
- UL60601-1: 2003

3.7.2 Classification of the device:

Protection against electric shock

Class II Medical Electrical Equipment.

Protection against harmful ingress of water or particulate matter

IPX2













Mode of operation

Continuous operation.

3.7.3 Classification of the applied parts:

ThermoSmart™ Breathing Tube and Breathing Tube are Type BF applied parts.

3.8 Symbol Definitions

	Class II Medical Electrical Equipment
	Type BF applied part
	ATTENTION: Consult accompanying documents
Rx only	Prescription only
	NZ Radio Interference C-tick mark
	Conforms with medical device directive 93/42/EEC
	Do not discard as regular rubbish
IPX2	Drip-proof
	Catalogue number
	Date of manufacture
	Serial number
	Authorized representative in the European community
	Alternating current
	UL Classified symbol
	Brazil INMETRO symbol

4. General Information of the Device

4.1 Information on all the Measuring Sensors and Display Unit

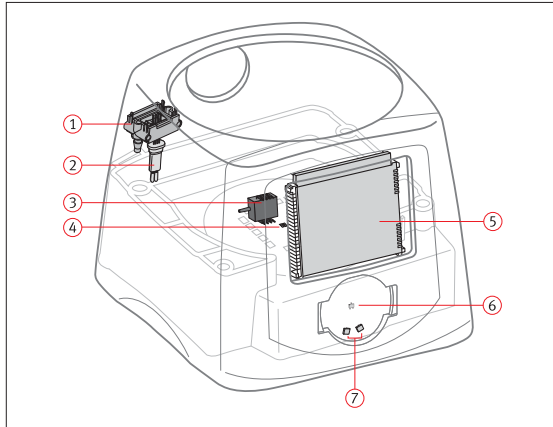

Figure 1

Location of differential pressure sensor, thermistors for measuring ambient temperature of the inlet air, pressure sensor, thermistors on heater-plate, LCD and Hall sensors for dial operation.

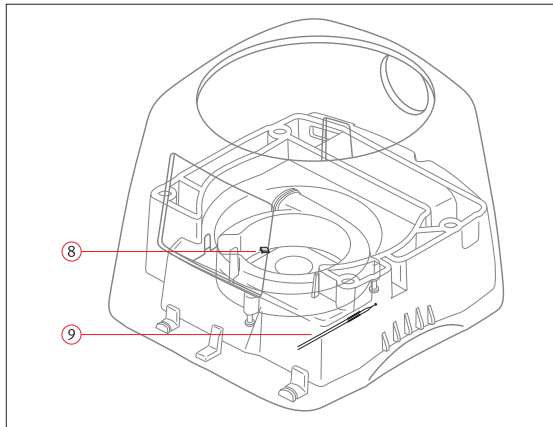

Figure 2

Location of Hall sensor of the motor and flow-sensing thermistor (Novo only).

Refer to Figure 1 and Figure 2 above.

NUMBER	DESCRIPTION	DETECTION RANGE
1	Differential pressure sensor for flow measurement. (F&P ICON Auto, F&P ICON Premo only)	Flow: -50 L/min to 160 L/min
2	2 thermistors to measure ambient temperature of the inlet air	34 °F to 99 °F (1 °C to 37 °C)
3	Pressure Sensor. (F&P ICON Auto, F&P ICON Premo only)	Pressure: 0 cmH ₂ O to 30 cmH ₂ O
4	2 thermistors for detecting the temperature of heater-plate.	77 °F to 185 °F (25 °C to 85 °C)
5	LCD for displaying the menu system.	Type: HTN
6	Hall sensor for detecting the position of the button.	Sensitivity: 5 mV/G Quiescent Voltage: 2.5 V Maximum Output Vout(H): 4.7 V Minimum Output Vout(L): 0.2 V Range: -44 mT to 44 mT
7	Hall sensors for detecting the rotation of the dial.	Operate Point: 1 to 6 mT Release Point: -6 to -1 mT
8	Hall sensor for detecting motor speed.	Operate Point: 1 to 6 mT Release Point: -6 to -1 mT
9	1 thermistor used as flow sensor. (F&P ICON Novo only)	0 L/min to 150 L/min
	1 thermistor used to measure local ambient temperature to compensate flow measurement. (F&P ICON Novo only)	36 °F to 140 °F (2 °C to 60 °C)

4.2 The Pneumatic Flow Path

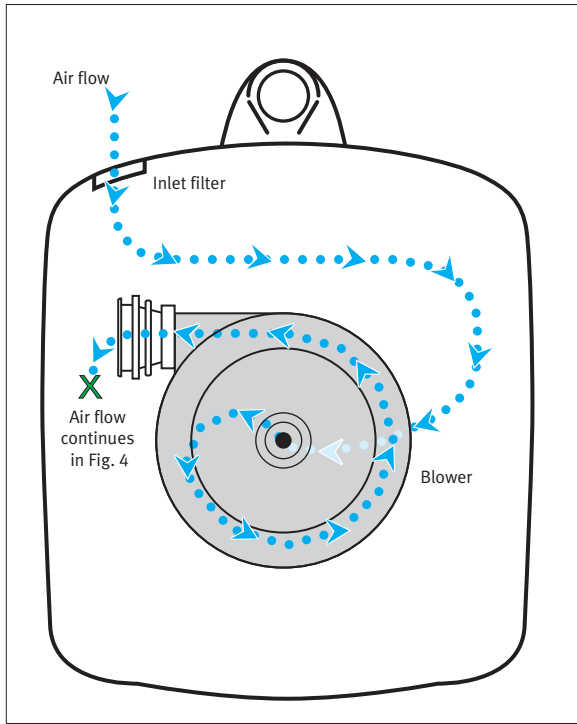

Figure 3

Air flow from rear of device to blower.

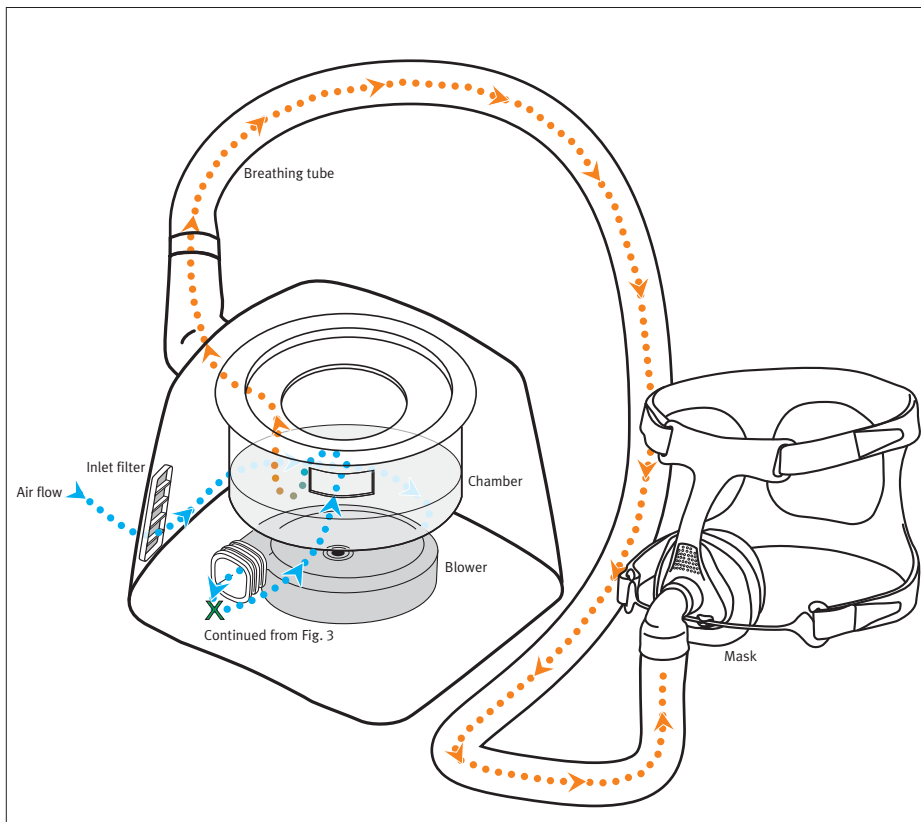

Figure 4

Air flow from rear of device to mask.

4.3 Operator-detachable Breathing Gas Pathway Components

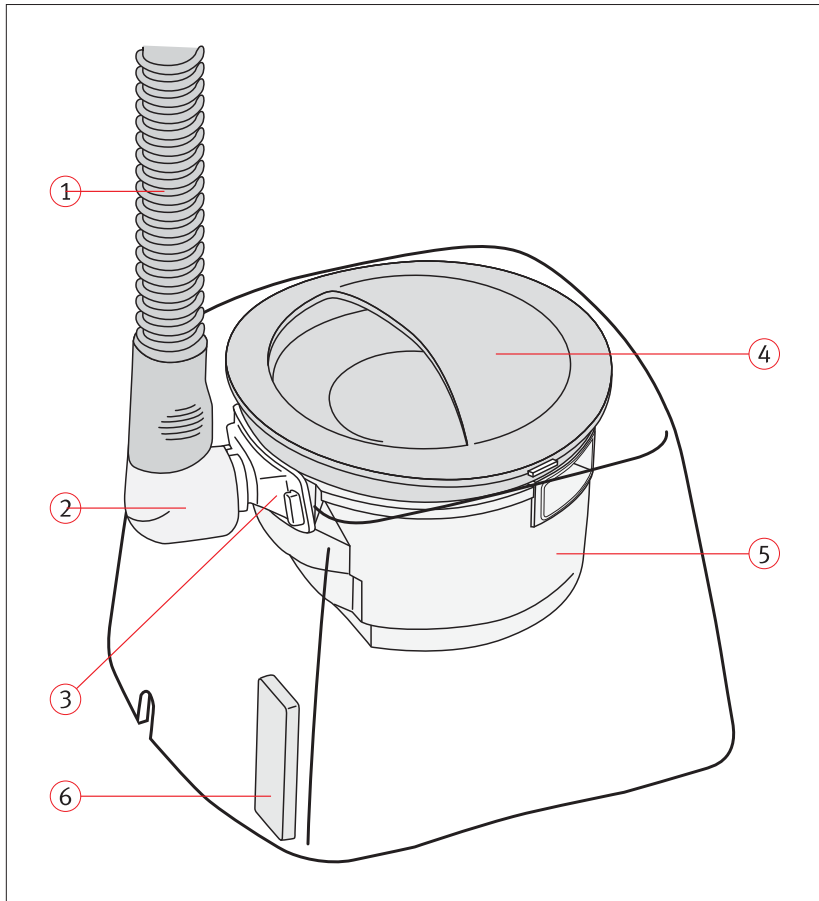

Figure 5
Operator-detachable
breathing gas pathway
components.

Refer to Figure 5 above.

NUMBER	NAME	PART NUMBER
1	ThermoSmart Breathing Tube	900ICON208
	Breathing Tube	900HC221
2	Elbow outlet	900ICON204
3	Outlet seal	900ICON206
4	Silver Gloss Lid	900ICON214
	Matt Grey Lid	900ICON216
	Charcoal Lid	900ICON217
5	Water Chamber	900ICON200
6	Filter	900ICON503

5. Operation

5.1 Important information

5.1.1 Before using the device:

Turn on the device by pushing the SmartDial™. The Main Display Screen will light up and the clock-face of the Menu System will rotate to indicate treatment is starting.

5.1.2 Function of the device after interruption and restoration of the power supply:

All the settings necessary for the operation of the device are permanently stored in the EEPROM of the device.

Note: Compliance information is stored to the EEPROM every 6 minutes.

After a power brown out or after an interruption of the power supply, the device will restart in the same mode before the power brown out or the interruption of the power supply occurs.

If the power brown out or the interruption of the power supply occurs during an auto-titration process, the device will restart the auto-titration process.

5.1.3 Interdependence of controls:

The SmartDial is the only input control for operating the device and navigating the Menu System. The dial and the button of the SmartDial work independently.

5.1.4 Error codes:

In the event of an error code detection, please refer to section 6.5 Error Codes.

6. Support Information

6.1 Note

- The device does not require routine servicing.
- Under no circumstances should the device be opened or any of the seven fastening screws on the underneath side of the device be loosened.
- Do not modify this equipment without authorization of the manufacturer. The only modification allowed to be performed is the upgrade of the software. Refer to Section 6.2 Upgrade of Software for the steps involved.
- Other servicing checks that can be performed on the device are the Electrical Safety Test outlined in Section 6.3 and the Performance Checks outlined in Section 7.
- No part of the device is designated as repairable by service personnel.
- No part of the device is designated as replaceable by service personnel, except for the replacement parts stated in the Use and Care Manual. Refer to the Use and Care Manual for the procedure for replacing such replacement parts.
- The non-detachable power supply cord is not replaceable.

6.2 Upgrade of Software

6.2.1 Procedure:

1. Make sure the device is not connected to the supply mains.
2. Remove the InfoUSB from the USB Port if present. Refer to the Use and Care manual on how to remove a InfoUSB from the USB Port.
3. Insert the InfoUSB with the new version of software into the USB Port.
4. Connect the device to the supply mains to power up the device.
5. The 16 points of the menu system will appear on the LCD. Rings will sequentially appear around the dots during the upgrade. When the upgrading process is finished, the Home Screen will be shown.

DO NOT DISCONNECT THE DEVICE FROM THE SUPPLY MAINS OR REMOVE THE InfoUSB FROM THE USB PORT DURING THE UPGRADING PROCESS OR AN ERROR WILL OCCUR.

6. When the Home Screen is shown remove InfoUSB with the new version of software from the USB Port.
7. Reinsert the original InfoUSB removed previously.

DO NOT LEAVE THE InfoUSB WITH THE NEW VERSION OF SOFTWARE IN THE USB PORT AS DOING SO WILL START THE UPGRADING PROCESS EVERY SINGLE TIME WHEN THE DEVICE IS POWERED UP.

6.2.2 Note:

- If the device is disconnected from the supply mains or if power supplying the device is interrupted during the upgrading process, the upgrading process will not be completed and an error code will appear on the LCD screen next time when power is reconnected.
- If an error code appears on the LCD screen when the device is powered up, disconnect the device from the supply mains. With the InfoUSB with the new software in the USB Port, connect the device to the supply mains to power up the device. The upgrading process will start again.
- If an error code keeps on appearing on the LCD screen when the upgrading process is retried, contact your local Fisher & Paykel Healthcare representative.

6.3 Electrical Safety Test

- To test for electrical safety, perform the following electrical safety tests and any other tests required by local regulations.

Inspection	Check the power cord for damage – cuts, stretching, wear, bent pins. Check that there is adequate cable restraint. Ensure the case is not damaged and fasteners are secure.
Insulation Resistance	Use a 500 VDC insulation tester to measure the resistance between the mains plug phase pin and the heater plate - it should be greater than 10M Ω . Repeat the test by measuring the resistance between the mains plug neutral pin to the heater plate.

6.4 Replacement Parts

DESCRIPTION	PART NUMBER
F&P InfoSmart CD	900SW100
F&P Studio™ CD	900ICON112
Water Chamber	900ICON200
InfoUSB 2	900ICON202
InfoUSB 2*	900ICON203
Elbow	900ICON204
Oxygen Elbow	900ICON205
Outlet seal	900ICON206
ThermoSmart™ Breathing Tube	900ICON208
Breathing Tube	900HC221
Air Filter	900ICON503
Air Filters 2 Pack	900ICON213
Silver Gloss Lid	900ICON214
Matt Grey Lid	900ICON216
Charcoal Lid	900ICON217
Filter grill	900ICON218
Carry-bag	900ICON315

* Not available in all countries

6.5 Error Codes

FAULT NO.	DESCRIPTION	INDICATION	ACTION
1.0-1.11	Flow Sensing Faults	Error symbol	Disconnect from power, then connect and re-start device. If error persists, return device
2.0-2.1	Pressure Sensing Faults	Error symbol	Disconnect from power, then connect and re-start device. If error persists, return device
3.0-3.4	Ambient Sensing Faults	Error symbol	Disconnect from power, then connect and re-start device. If error persists, return device
4.0-4.4	Heater Plate Faults	Error symbol	Disconnect from power, then connect and re-start device. If error persists, return device
5.0-5.8	Motor Faults	Error symbol	Disconnect from power, then connect and re-start device. If error persists, return device
7.0-7.5	USB Faults	Error symbol	Ensure pressure is off. Remove the InfoUSB, then reinsert. If error persists, try a different InfoUSB. If error persists, return the device and InfoUSB
9.0 and 9.3	Heated Breathing Tube - tube fault	Flashing ThermoSmart symbol on the LCD screen (no error symbol)	Disconnect from power, then connect and re-start the device. If error persists, attach a new ThermoSmart breathing tube
9.1, 9.2, 9.4-9.16	Heated Breathing Tube - device fault	Error symbol on the LCD screen (ThermoSmart symbol turned off)	Device fault, return the device
12.0-12.2	Model Configuration Faults	Error symbol	Disconnect from power, then connect and re-start device. If error persists, return device
13.0-13.1	Power Faults	Error symbol	Disconnect from power, then connect and re-start device. If error persists, return device

7. Performance Checks

7.1 Note

- The device does not require routine performance checks or calibration.
- All performance checks should be conducted under the following ambient conditions:
Temperature: 73 ± 4 °F (23 ± 2 °C), Humidity: $50 \pm 5\%$ RH, Atmospheric Pressure: 101.3 ± 0.7 kPa.

7.2 Pressure Sensor Test

7.2.1 Equipment required:

- The device to be tested with the ThermoSmart Breathing Tube or Breathing Tube attached.
- A Fisher & Paykel HC325 Chamber.
- A manometer. Fisher & Paykel water manometer part number 900HC224 is recommended.
If an alternative manometer is used, there should be a bias flow opening of 4mm diameter and the pressure measurement shall be taken as close to the HC325 Chamber as possible because any additional tubing will cause a pressure drop and affect the result.

7.2.2 Procedure:

1. Fill the HC325 chamber with water to approximately 1/3 of the full capacity. The printed line on the chamber shows the full capacity of the chamber.
2. Connect the water manometer 900HC224 to one of the outlet ports of the HC325 Chamber. Slide the plastic tube of the manometer up or down until the “-0-” mark aligns with the water level in the Chamber.
3. Connect the ThermoSmart™ Breathing Tube of the device to the other outlet port HC325 Chamber.
4. Connect the device to the supply mains to power up the device.
5. If Time is displayed on the Home Screen, change to display the pressure. Refer to the Use and Care Manual on how to change to display pressure on the Home Screen.
6. For the Novo model, ensure that altitude is set correctly for the current device location. Adjust the altitude setting if it is incorrect. Refer to the Use and Care Manual on how to adjust the altitude setting.
7. Start the pressure delivery. Refer to the Use and Care Manual on how to start the pressure delivery.
8. Wait until the pressure reading shown on the LCD has stabilized.
9. Wait until the water level in the water manometer 900HC224 rests at a level. If another type of manometer is used, wait until the reading has stabilized.
10. The scale of the water manometer 900HC224 is cmH₂O. The reading on the water manometer should be within 1 cmH₂O of the value displayed on the LCD.
11. Stop the pressure delivery. Refer to the Use and Care Manual on how to stop the pressure delivery.
12. If Time was displayed on the Home Screen before this test was performed, change to display time on Home Screen. Refer to the Use and Care Manual on how to change to display time on the Home Screen.
13. The same setup is required for the Heater Plate Test in Section 7.3.

7.2.3 Note:

- The pressure value shown on the manometer assumes that the device has been running for at least 30 minutes – if this is not the case, the pressure shown in the manometer may be up to approximately 0.5 cmH₂O higher.
- Equation to correct the measured CPAP pressure for atmospheric pressure changes:

$$P'_{\text{CPAP}} = P_{\text{CPAP}} \frac{101.3}{P_{\text{AT}}}$$

P'_{CPAP} is the corrected CPAP pressure in cmH₂O

P_{CPAP} is the measured CPAP pressure in cmH₂O

P_{AT} is the measured atmospheric pressure in kPa



7.3 Heater Plate Test

- Perform this test immediately after performing the Pressure Sensor Test in Section 7.2.

7.3.1 Equipment list:

- Refer to the equipment list in the Pressure Sensor Test in Section 7.2.

7.3.2 Procedure:

1. Take the Water Chamber out of the device and fill the Water Chamber with water **up to the maximum water line** which is marked on the side of the Water Chamber. Refer to the Use and Care Manual for the location of the water line.
2. Replace the Water Chamber back into the device and close the Chamber Lid. Refer to the Use and Care Manual for the correct method of replacing the Water Chamber and the lid back to the device.
3. **Record the Humidity setting** from the Humidity Menu. It should be a number from 0 to 7. Refer to the Use and Care Manual on how to get the humidity setting.
4. **Record the humidity Boost Level** from the Humidity Menu. It should be between low  and high . Refer to the Use and Care Manual on how to get the humidity Boost level.
5. **Change the humidity setting to 4 and the humidity Boost Level to medium** .
6. Start the pressure delivery. Refer to the Use and Care Manual on how to start the pressure delivery.
7. Let the device run for 40 minutes to allow the temperature of the water in the Water Chamber to stabilize.
8. Stop the pressure delivery. Refer to the Use and Care Manual on how to stop the pressure delivery.
9. Remove the Chamber Lid and measure the temperature of the water in the Water Chamber. The temperature of the water should be between 95 °F (35 °C) and 113 °F (45 °C).
10. Remove the Water Chamber from the device and pour out the water.
11. Replace the Water Chamber back into the device and fit the Chamber Lid back.
12. Change the Humidity setting back to the value recorded in Step 3.
13. Change the humidity Boost Level back to the value recorded in Step 4.
14. The same setup is required for the ThermoSmart™ Breathing Tube Disconnection Warning Test in Section 7.4.

7.4 ThermoSmart Breathing Tube Disconnection Indicator

- Perform this test immediately after performing the Heater Plate Test in Section 7.3.

Note: This test is only applicable when the device is connected to a ThermoSmart Breathing Tube.

7.4.1 Equipment list:

- Refer to the equipment list in the Pressure Sensor Test in Section 7.2.

7.4.2 Procedure:

1. Start the pressure delivery.
2. Allow the device to run for 1 minute until the pressure delivered has stabilized.
3. Remove the ThermoSmart Breathing Tube from the Elbow.
4. The ThermoSmart Logo at the top left corner of the LCD should disappear within 10 seconds.
5. Replace the ThermoSmart Breathing Tube back to the Elbow.
6. The ThermoSmart Logo at the top left corner of the LCD should appear within 10 seconds.
7. Stop the pressure delivery.

Note: If any of the tests above fail, please contact your Fisher & Paykel Healthcare representative.

8. Device Disposal Instructions



This device contains electronics. Do not discard as regular rubbish.

Return to Fisher & Paykel Healthcare or dispose according to local guidelines for disposing of electronics.

Appendix A: IEC60601-1-2 EMC TABLES

Guidance and Manufacturer's Declaration - Electromagnetic Emissions

The F&P ICON+ Series is intended for use in the electromagnetic environment specified below. The customer or the user of the F&P ICON+ Series should ensure that it is used in such an environment.

EMISSIONS TEST	COMPLIANCE	ELECTROMAGNETIC ENVIRONMENT - GUIDANCE
RF emissions CISPR 11	Group 1	The device uses RF energy only for its internal function. Therefore, its RF emissions are very low and are not likely to cause any interference in nearby electronic equipment.
RF emissions CISPR 11	Class B	The device is suitable for use in all establishments, including domestic establishments and those directly connected to the public low-voltage power supply network that supplies buildings used for domestic purposes.
Harmonic emissions IEC 61000-3-2	Class A	
Voltage fluctuations flicker emissions IEC 61000-3-3	Complies	

Guidance and Manufacturer's Declaration - Electromagnetic Immunity

The F&P ICON+ Series is intended for use in the electromagnetic environment specified below. The customer or the user of F&P ICON+ Series should ensure that it is used in such an environment.

IMMUNITY TEST	IEC60601 TEST LEVEL	COMPLIANCE LEVEL	ELECTROMAGNETIC ENVIRONMENT - GUIDANCE
Electrostatic discharge (ESD) IEC61000-4-2	± 6 kV contact ± 8 kV air	± 2 kV contact ± 8 kV air See Notes 2 & 3 below	Floors should be wood, concrete or ceramic tile. If floors are covered with synthetic material, the relative humidity should be at least 30%. It may be necessary to take ESD precautions if the Humidifier resets during use. The Humidifier should not be used near earthed metal objects to which an electrostatic discharge may be applied.
Electrical fast transient/burst IEC61000-4-4	± 2 kV for power supply lines	± 2 kV	Mains power quality should be that of a typical commercial or hospital environment.
Surge IEC 61000-4-5	± 1 kV differential mode ± 2 kV common mode	± 1 kV ± 2 kV	Mains power quality should be that of a typical commercial or hospital environment.
Voltage dips, short interruptions and voltage variations on power supply input lines IEC 61000-4-11	$< 5\% U_T$ ($> 95\%$ dip in U_T) for 0.5 cycle $40\% U_T$ (60% dip in U_T) for 5 cycles $70\% U_T$ (30% dip in U_T) for 25 cycles $< 5\% U_T$ ($> 95\%$ dip in U_T) for 5 sec	$< 5\% U_T$ ($> 95\%$ dip in U_T) for 0.5 cycle $40\% U_T$ (60% dip in U_T) for 5 cycles $70\% U_T$ (30% dip in U_T) for 25 cycles $< 5\% U_T$ ($> 95\%$ dip in U_T) for 5 sec	Mains power quality should be that of a typical commercial or hospital environment. If the user of the device requires continued operation during power interruptions, it is recommended the device be powered from an uninterruptible power supply or a battery.
Power frequency (50/60 Hz)/magnetic field IEC 61000-4-8	3 A/m	3 A/m	Power frequency magnetic fields should be at levels characteristic of a typical location in a typical commercial or hospital environment.

NOTE 1: U_T is the a.c. mains voltage prior to application of the test level.

NOTE 2: ESD testing was conducted at 2, 4 and 6 kV. When the 4 and 6 kV discharges were applied to ground planes the device reset. There was no interruption during the 2 kV discharges.

NOTE 3: During some aspects of EMC testing (immunity), the device may reset briefly. This will be characterised by the LCD blanking followed by the model number being displayed and/or a brief drop in motor speed. These conditions are considered acceptable by Fisher & Paykel Healthcare Ltd as the prescribed therapy would only be reduced for a short duration with the worst-case result being a temporary disturbance in the patient's sleep. Safety of both patient and device are not compromised under these circumstances.

Guidance and Manufacturer's Declaration - Electromagnetic Immunity

The F&P ICON+ Series is intended for use in the electromagnetic environment specified below. The customer or the user of the F&P ICON+ Series should ensure that it is used in such an environment.

IMMUNITY TEST	IEC60601 TEST LEVEL	COMPLIANCE LEVEL	ELECTROMAGNETIC ENVIRONMENT - GUIDANCE
Conducted RF IEC 61000-4-6 Radiated RF IEC 61000-4-3	3 Vrms 150 kHz to 80 MHz 3 V/m 80 MHz to 2,5 GHz	3 Vrms 3 V/m	<p>Portable and mobile RF communications equipment should be used no closer to any part of the device, including cables, than the recommended separation distance calculated from the equation applicable to the frequency of the transmitter.</p> <p>Recommended separation distance</p> <p>d = 1.2 √P d = 1.2 √P 80 MHz to 800 MHz d = 2.3 √P 800 MHz to 2.5 GHz</p> <p>where P is the maximum output power rating of the transmitter in watts (W) according to the transmitter manufacturer and d is the recommended separation distance in metres (m). Field strengths from fixed RF transmitters, as determined by an electromagnetic site survey,^a should be less than the compliance level in each frequency range.^b Interference may occur in the vicinity of equipment marked with the following symbol:</p> 
NOTE 1: At 80 MHz and 800 MHz, the higher frequency range applies.			
NOTE 2: These guidelines may not apply in all situations. Electromagnetic propagation is affected by absorption and reflection from structures, objects and people.			
^a Field strengths from fixed transmitters, such as base stations for radio (cellular/cordless) telephones and land mobile radios, amateur radio, AM and FM radio broadcast and TV broadcast can not be predicted theoretically with accuracy. To assess the electromagnetic environment due to fixed RF transmitters, an electromagnetic site survey should be considered. If the measured field strength in the location in which the device is used exceeds the applicable RF compliance level above, the device should be observed to verify normal operation. If abnormal performance is observed, additional measures may be necessary, such as re-orienting or relocating the device.			
^b Over the frequency range 150 kHz to 80 MHz, field strengths should be less than 3 V/m.			

Recommended separation distances between portable and mobile RF communications equipment and the F&P ICON+ Series

The F&P ICON+ Series is intended for use in the electromagnetic environment in which radiated RF disturbances are controlled. The customer or the user of the F&P ICON+ Series can help prevent electromagnetic interference by maintaining a minimum distance between portable and mobile RF communications equipment (transmitters) and the F&P ICON+ Series as recommended below, according to the maximum output power of the communications equipment.

Rated maximum output power of transmitter W	SEPARATION DISTANCE ACCORDING TO FREQUENCY OF TRANSMITTER M		
	150 kHz to 80 MHz d = 1.2 √P	80 MHz to 800 MHz d = 1.2 √P	800 MHz to 2.5 GHz d = 2.3 √P
0.01	0.12	0.12	0.23
0.1	0.38	0.38	0.73
1	1.2	1.2	2.3
10	3.8	3.8	7.3
100	12	12	23
For transmitters rated at maximum output power not listed above, the recommended separation distance d in meters (m) can be estimated using the equation applicable to the frequency of the transmitter, where P is the maximum output power rating of the transmitter in watts (W) according to the transmitter manufacturer.			
NOTE 1: At 80 MHz and 800 MHz, the separation distance for the higher frequency range applies.			
NOTE 2: These guidelines may not apply in all situations. Electromagnetic propagation is affected by absorption and reflection from structures, objects and people.			

For more information please contact
your local Fisher & Paykel Healthcare representative

Manufacturer 

Fisher & Paykel Healthcare Ltd
15 Maurice Paykel Place
East Tamaki, Auckland 2013

PO Box 14 348 Panmure
Auckland 1741
New Zealand

Tel: +64 9 574 0100
Fax: +64 9 574 0158
Email: info@fphcare.co.nz
Web: www.fphcare.com

Australia

Fisher & Paykel Healthcare Pty Limited
36-40 New Street, PO Box 167
Ringwood, Melbourne
Victoria 3134, Australia

Tel: +61 3 9879 5022
Fax: +61 3 9879 5232

Austria

Tel: 0800 29 31 23
Fax: 0800 29 31 22

Benelux

Tel: +31 40 216 3555
Fax: +31 40 216 3554

China

Tel: +86 20 3205 3486
Fax: +86 20 3205 2132

France

Tel: +33 1 6446 5201
Fax: +33 1 6446 5221

Germany

Tel: +49 7181 98599 0
Fax: +49 7181 98599 66

India

Tel: +91 80 4284 4000
Fax: +91 80 4123 6044

Irish Republic

Tel: 1800 409 011

Italy

Tel: +39 06 7839 2939
Fax: +39 06 7814 7709

Japan

Tel: +81 3 3661 7205
Fax: +81 3 3661 7206

Northern Ireland

Tel: 0800 132 189

Spain

Tel: +34 902 013 346
Fax: +34 902 013 379

Sweden

Tel: +46 8 564 76 680
Fax: +46 8 36 63 10

Switzerland

Tel: 0800 83 47 63
Fax: 0800 83 47 54

Taiwan

Tel: +886 2 8751 1739
Fax: +886 2 8751 5625

Turkey

Fisher Paykel Sağlık Ürünleri
Ticaret Limited Şirketi,
P.O. Box 06371 Ostim,
Alinteri Bulvari 1161/1 Sokak
No. 12-14, Ankara, Turkey

Tel: +90 312 354 34 12
Fax: +90 312 354 31 01

UK 

Fisher & Paykel Healthcare Ltd
Unit 16, Cordwallis Park
Clivemont Road, Maidenhead
Berkshire SL6 7BU, UK

Tel: +44 1628 626 136
Fax: +44 1628 626 146

USA/CANADA

Tel: +1 800 446 3908
or +1 949 453 4000
Fax: +1 949 453 4001